Modern Wireless Networks

Cellular Networks



UNIVERSITY
AT ALBANY
State University of New York

IECE 574– Spring 2021

Prof. Dola Saha

Cellular Generations

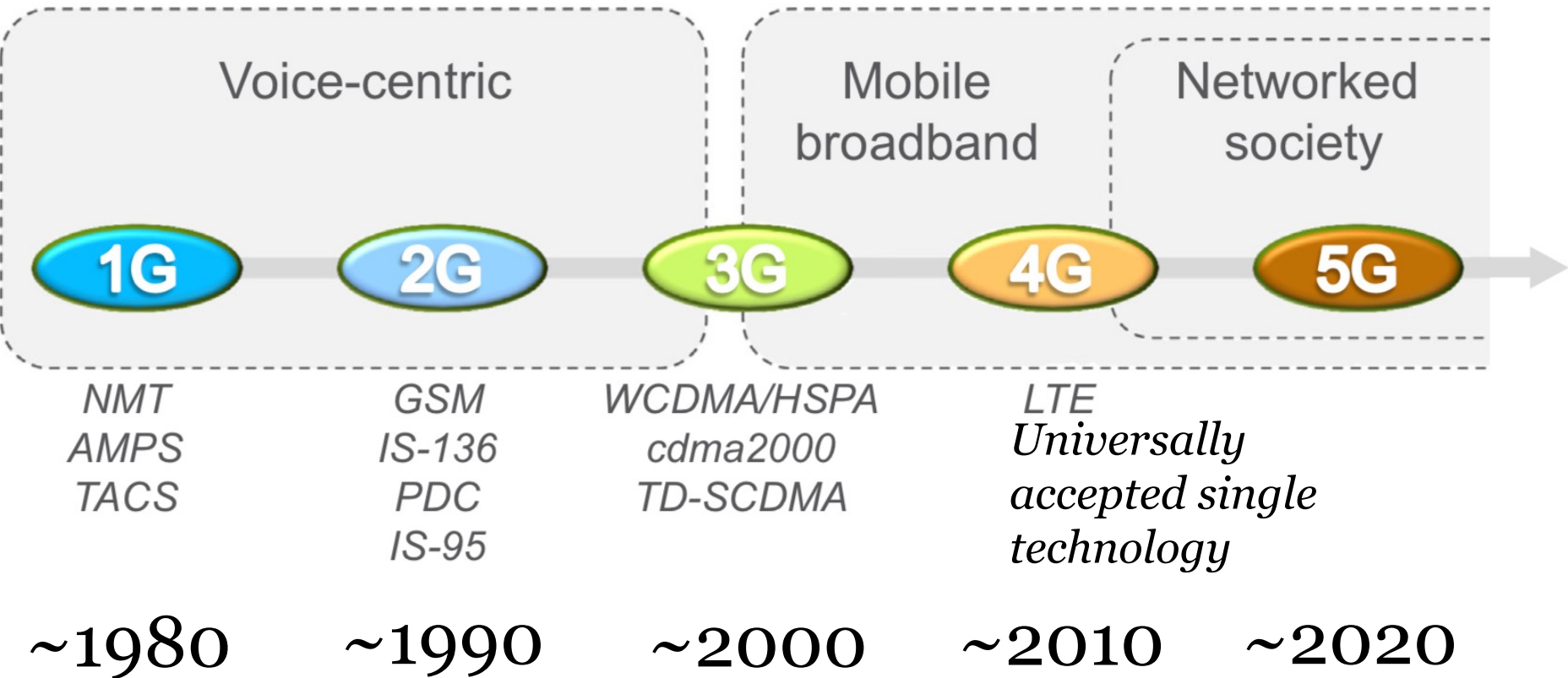

Convergence of Wireless Technologies

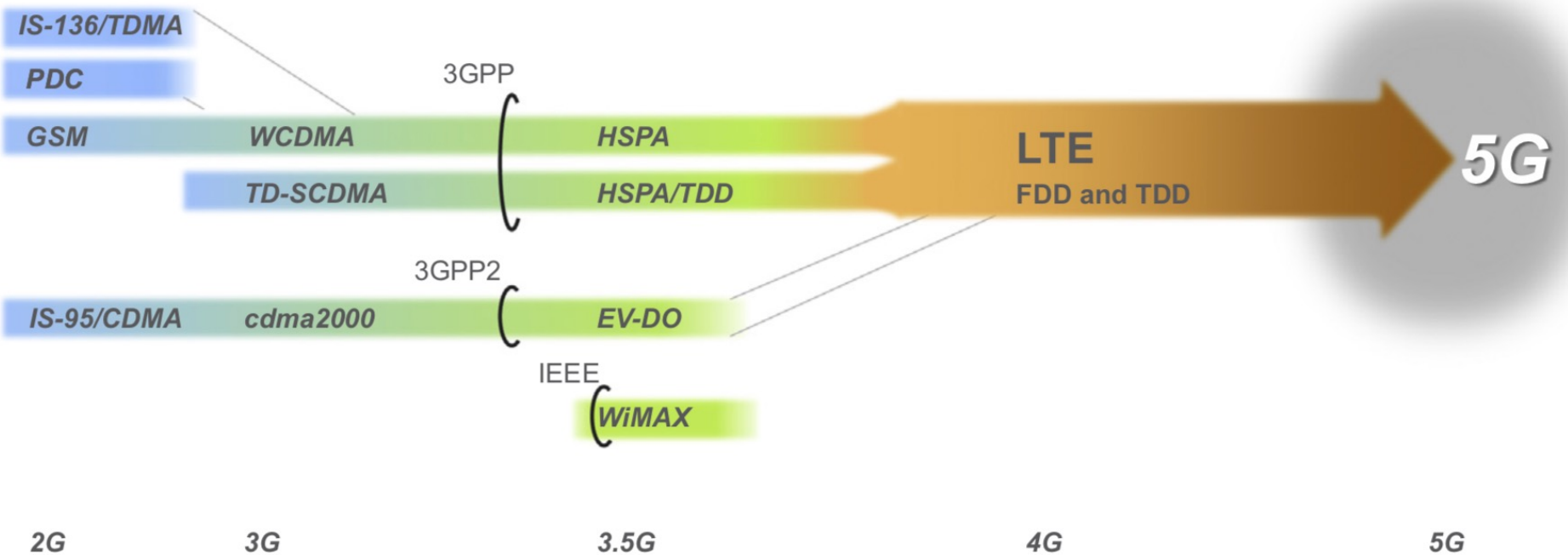

The Next Generation – 5G/NR

- Discussions on fifth-generation (5G) mobile communication began around 2012.
- The term 5G is *often* used to refer to specific new 5G radio-access technology.
- 5G Use Cases:
 - enhanced mobile broadband (eMBB),
 - massive machine-type communication (mMTC), and
 - ultra-reliable and low-latency communication (URLLC)

5G Use Case Classification

Examples?

eMBB

High data rates, high traffic volumes



mMTC

Massive number of devices,
low cost, low energy consumption

URLLC

Very low latency,
very high reliability and availability

5G Use Case Classification

eMBB

High data rates, high traffic volumes

Virtual Reality

4K video

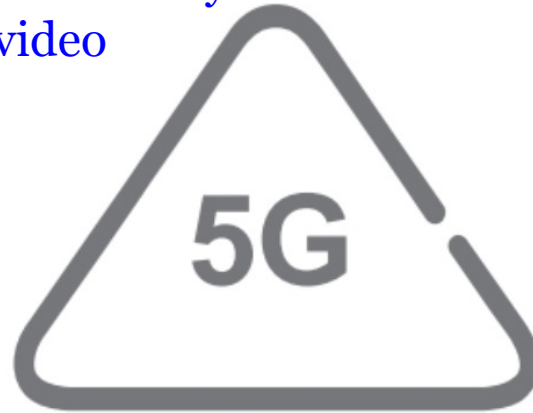

5G

Traffic Safety

Factory Automation

URLLC

Very low latency,
very high reliability and availability

Massive number of
remote
sensors/actuators

mMTC

Massive number of devices,
low cost, low energy consumption

NR – New 5G Radio-Access Technology

- All requirements were not met by LTE
- 3GPP initiated the development of a new radio-access technology known as NR (New Radio)

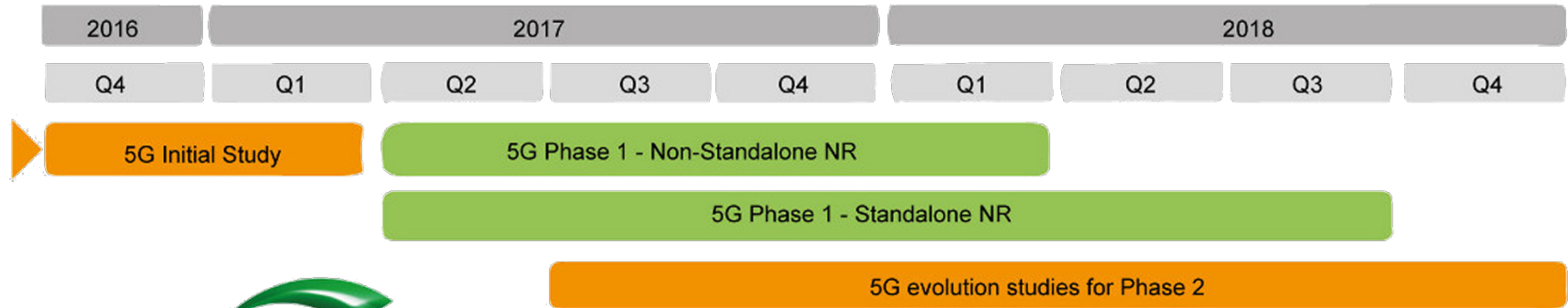

Non-Standalone

Uses LTE core and LTE radio anchor with a 5G small cell
Mobile BroadBand capacity boost

Standalone

Uses 5G core and 5G radio anchor
5G overlay
Expansion of the wireless ecosystem

"5G product supports either 'NG NR'
or 'access via a 5G CN'
or both."

Erik Gultman, 3GPP SA Chairman

5G Wireless Access

- More Spectrum
- Tight interworking with LTE
- Not restricted to be backward compatible
- Standalone mode
- 5G Core Network (5GCN) is under development

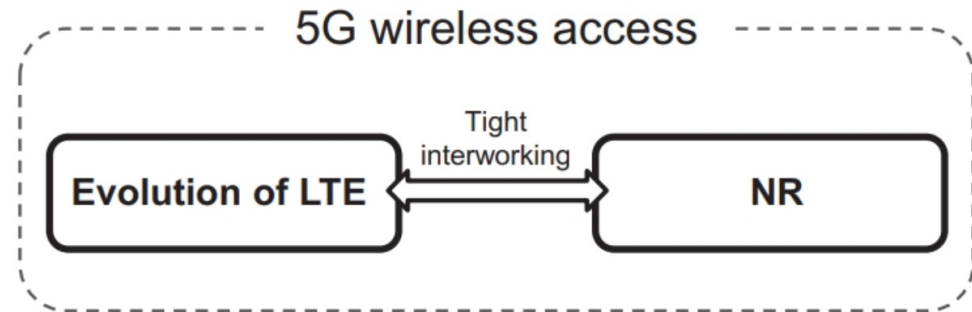

Standardization

- Coordinated international effort by wireless industry
- Depends on Global & Regional regulations
- Interoperability of the products
- Multiple organizations involved in creating technical specifications and standards as well as regulation
 - Standards Developing Organizations (SDOs)
 - Regulatory bodies and administrations
 - Industry Forums

Standards Developing Organizations

- Develop and agree on technical standards for mobile communications systems
- Protocol to communicate is standardized
- Proprietary solutions possible (like scheduling)
- Usually nonprofit industry organizations and not government controlled
- Example: 3GPP

Regulatory bodies and administrations

- Government-led organizations that set regulatory and legal requirements for selling, deploying, and operating mobile systems and other telecommunication products.
- Spectrum allocation, amount of emissions from a Tx.
- **International Telecommunications Union (ITU)** handles spectrum regulation on a Global level.
- **Federal Communications Communications (FCC)** for USA.

Industry Forums

- Industry-led groups promoting and lobbying for specific technologies or other interests
- Mostly led by network operators
- Examples: Next Generation Mobile Networks (NGMN), 5G Americas

Organizations in Cellular Network

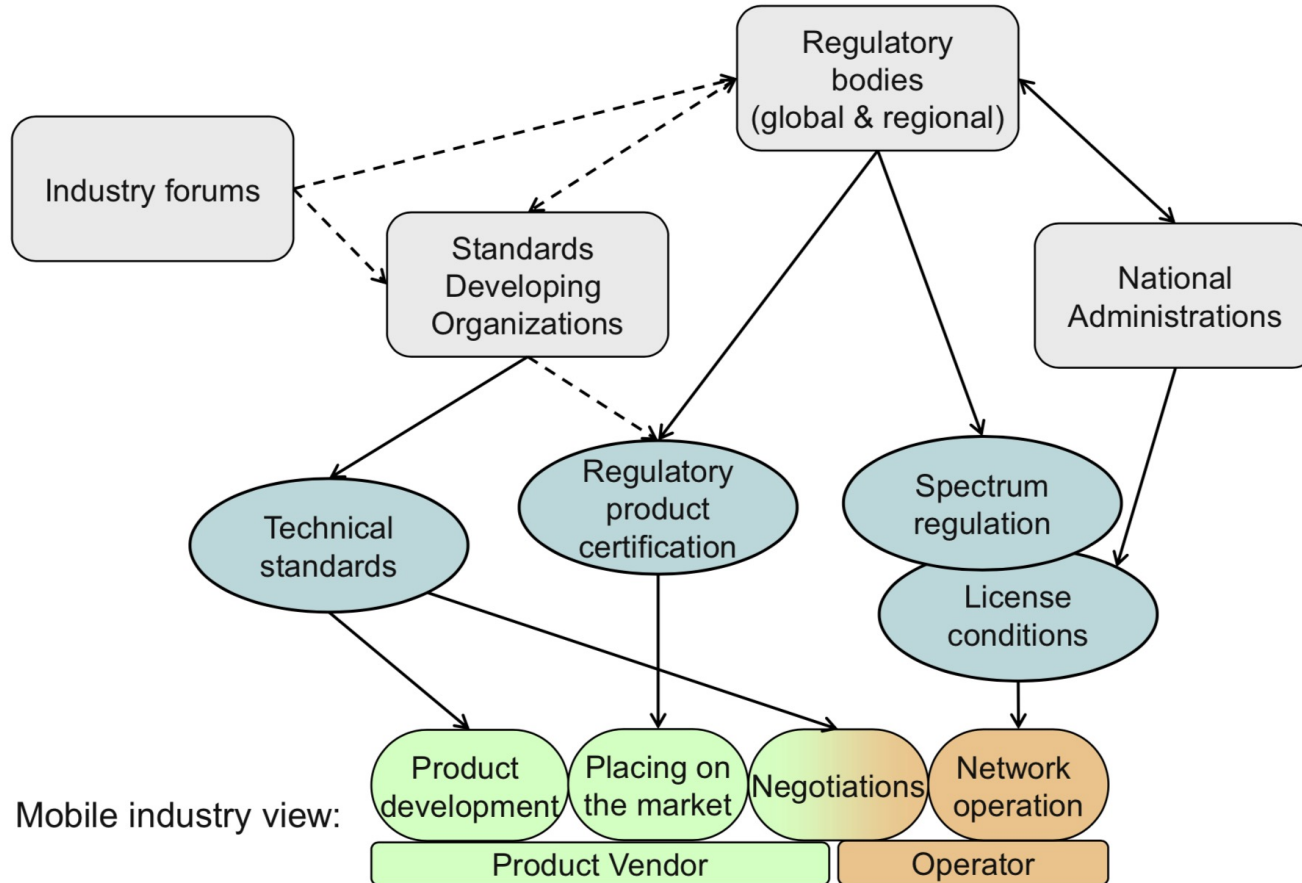

Requirements

- ITU-R is the radio communications sector of the International Telecommunications Union (ITU).
- ITU-R defines the spectrum for different services in the RF spectrum
- International Mobile Telecommunications (IMT) – requirements issued by ITU-R.
- The framework and objective for IMT-2020 is outlined in ITU-R Recommendation M.2083.

Workplan for IMT-2020 in ITU-R

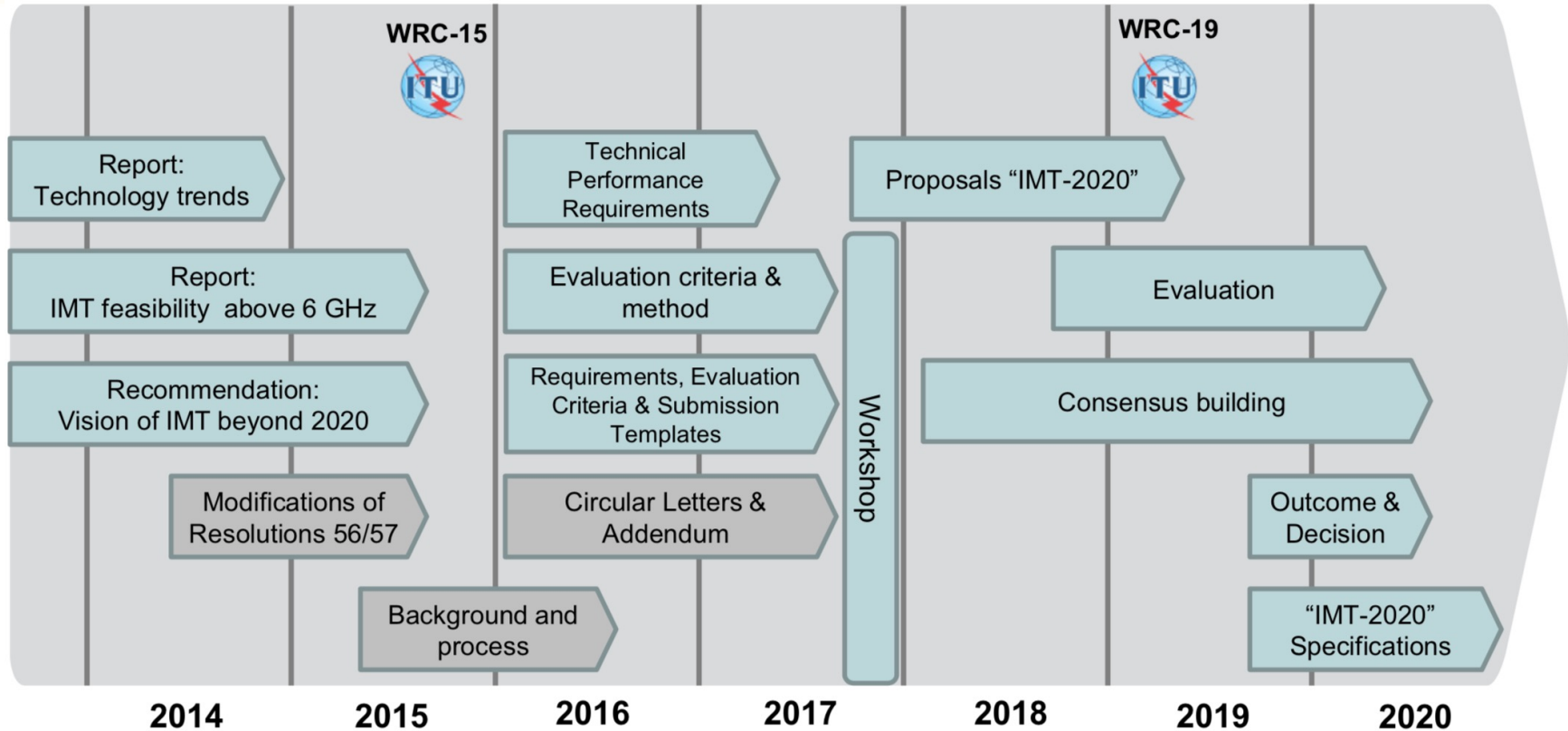

IMT 2020 Requirement (ITU-R M.2083)

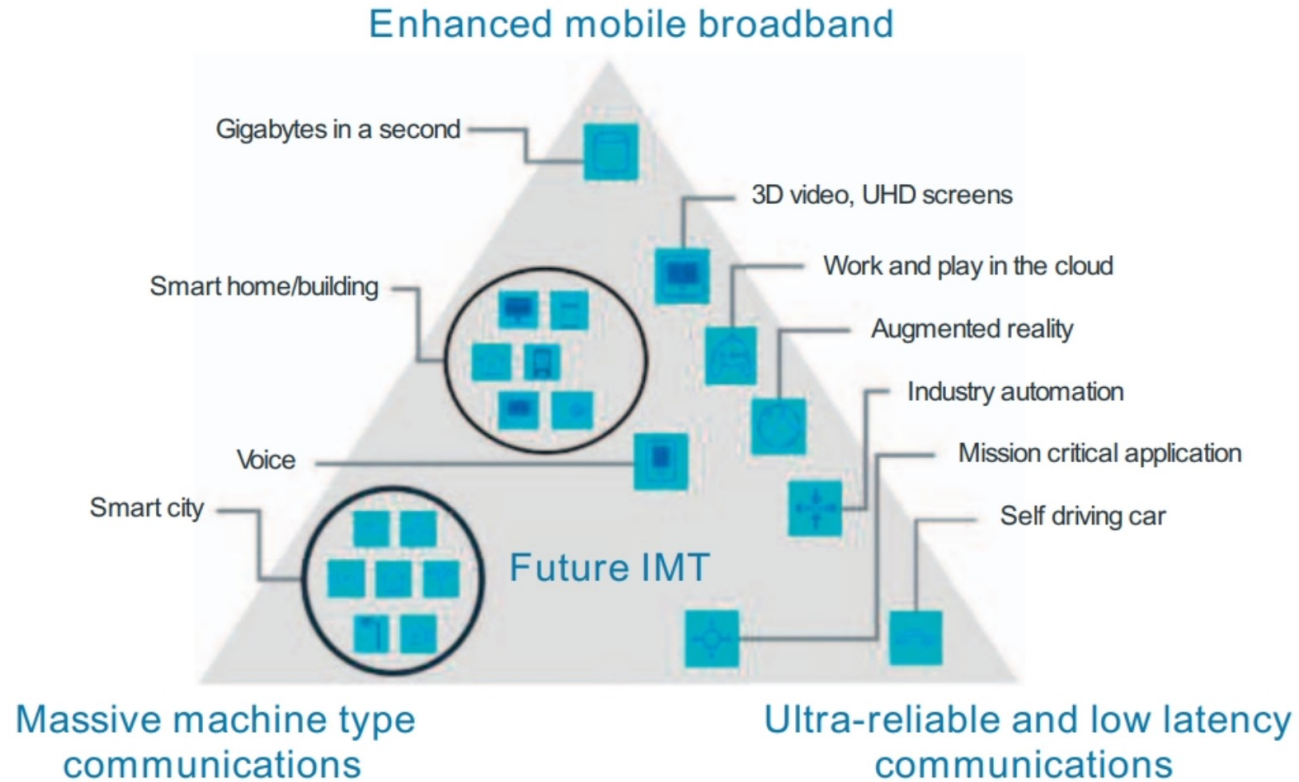

Recommendation ITU-R M.2083

Capabilities

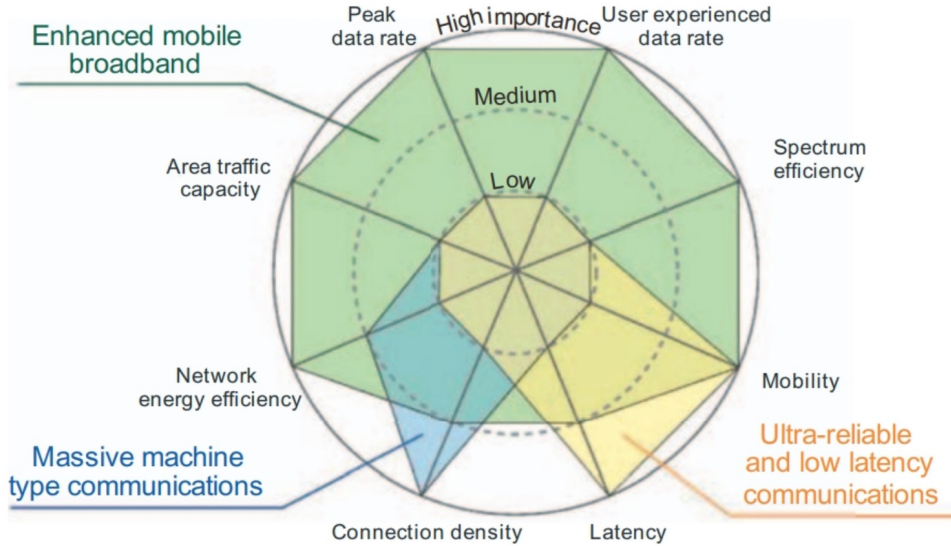
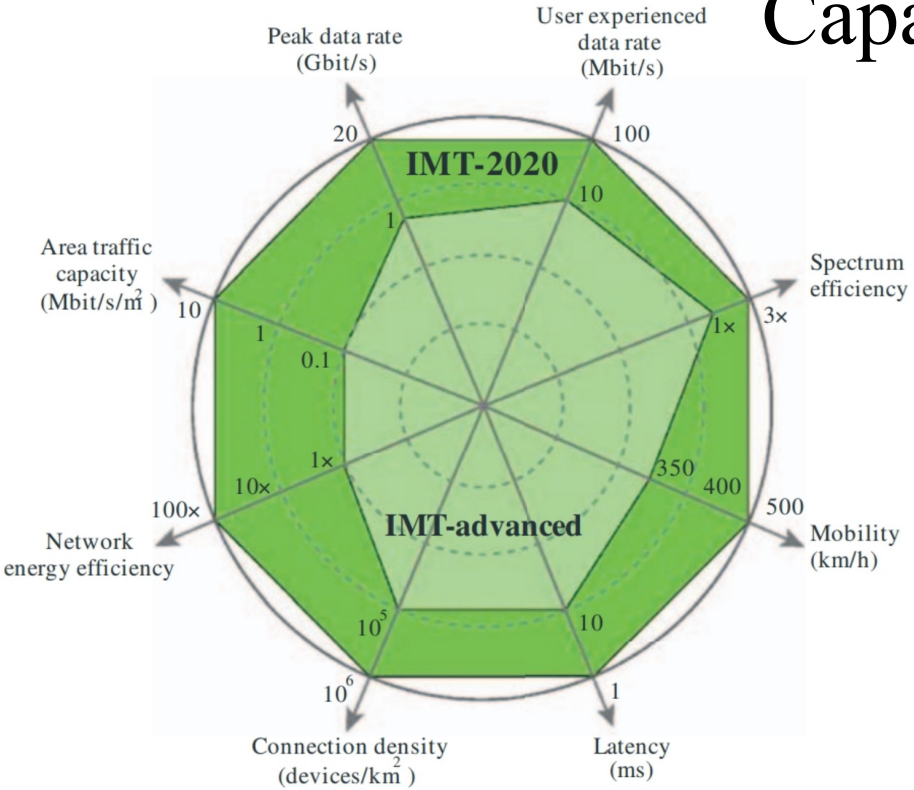

Capabilities – IMT 2020

- Peak data rate
 - = System bandwidth x Peak spectral efficiency
- The user experienced data rate
 - the data rate that can be achieved over a large coverage area for a majority of the users
- Spectrum efficiency
 - the average data throughput per Hz of spectrum and per “cell” (or TRP)
- Area traffic capacity
 - = Spectrum efficiency x BW x TRP density

Capabilities – IMT 2020

- Network energy efficiency
 - Energy consumed per bit of data (Tx & Rx)
- Latency (10 fold reduction compared to IMT Advanced)
- Mobility (500Km/hr)
- Connection Density

Additional Capabilities – IMT 2020

- Spectrum and bandwidth flexibility
- Reliability (very high level of availability)
- Resilience (operate correctly after disturbance)
- Security & Privacy
- Operational lifetime (example, machine-type devices requiring a very long battery life > 10 years)

3GPP Standardization

- Requirements: what is to be achieved by the specification.
- Architecture: the main building blocks and interfaces are decided.
- Detailed specifications: every interface is specified in detail.
- Testing and verification: the interface specifications are proven

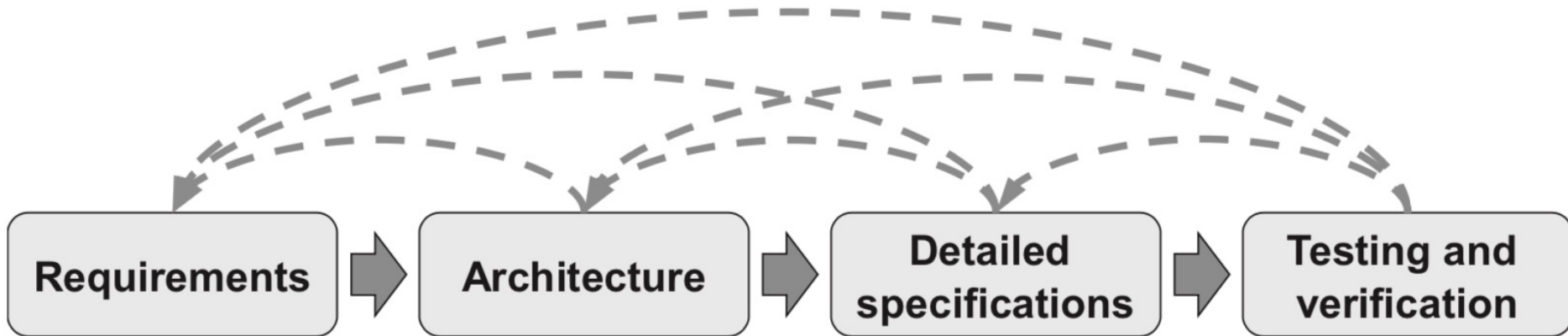

3GPP Technical Specifications Groups

- RAN
- Services & System Aspects
- Core Network & Terminals

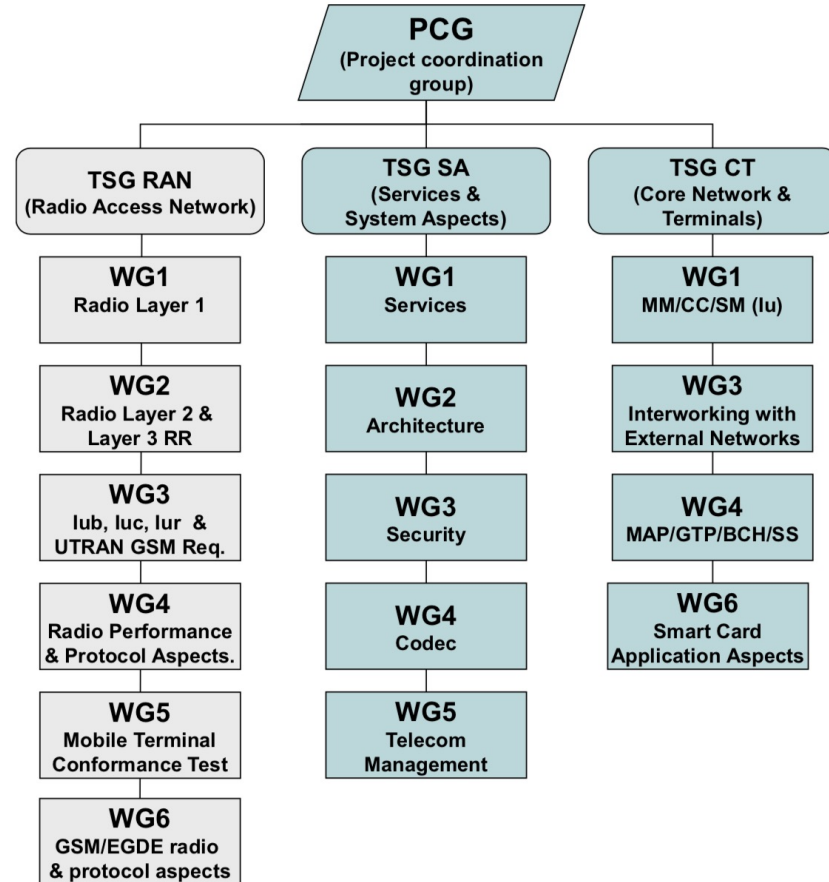

Spectrum for LTE

➤ Paired bands

- separated frequency ranges are assigned for uplink and downlink
- used for Frequency Division Duplex (FDD) operation

➤ Unpaired bands

- single shared frequency range for both uplink and downlink
- used for Time Division Duplex (TDD) operation

➤ Unpaired downlink only bands

- used for carrier aggregation for supplemental downlink

Bands allocated above 1GHz for LTE

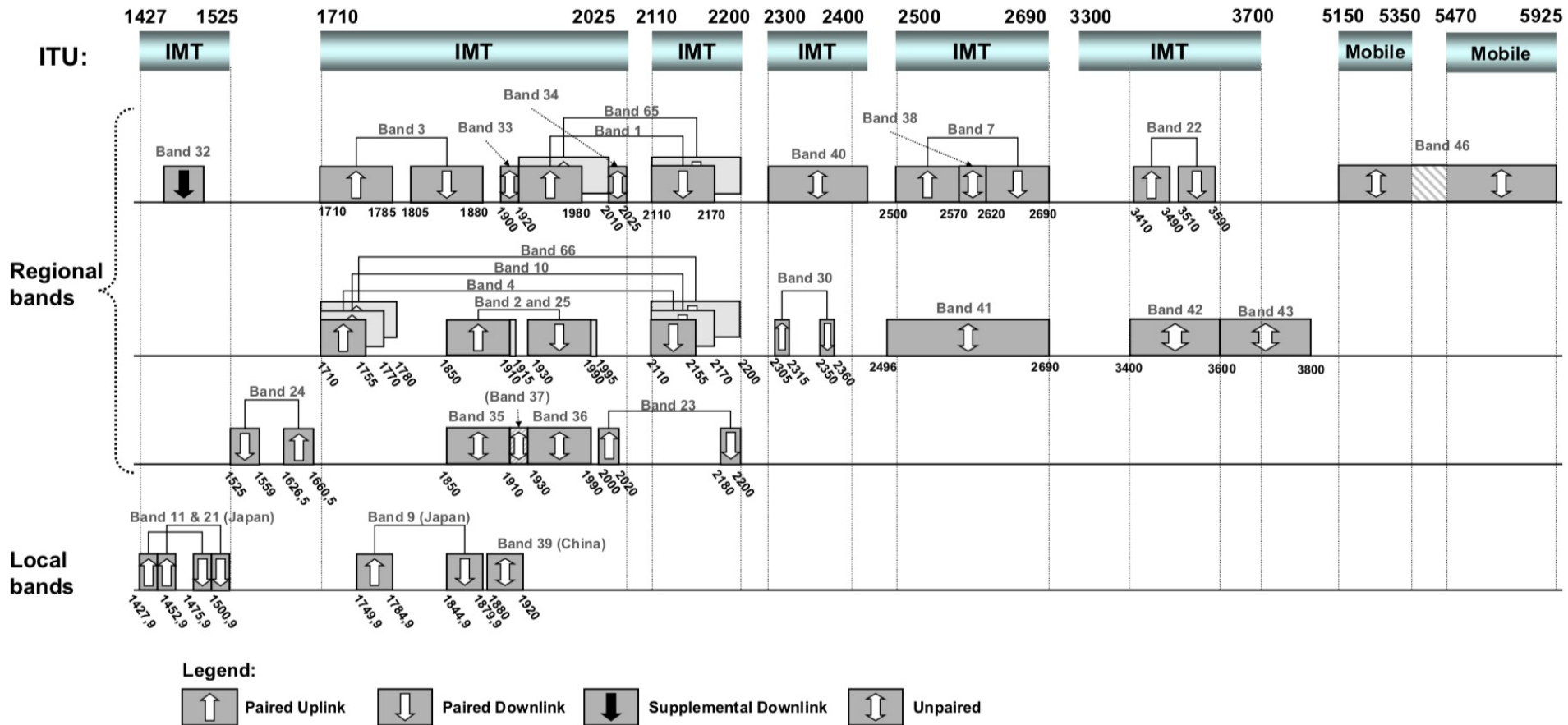

Bands Allocated below 1GHz for LTE

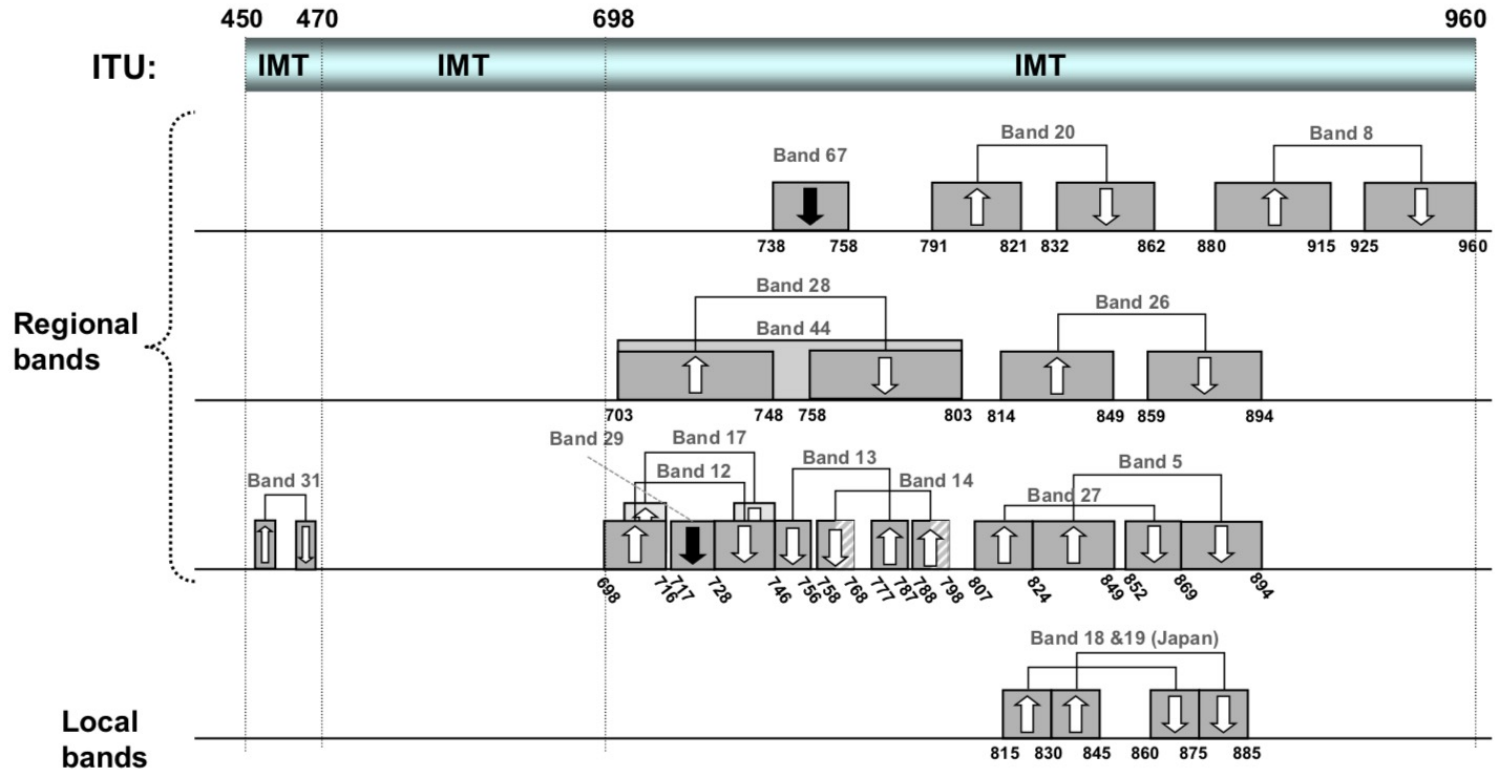

Legend:



Paired Uplink



Paired Downlink



Supplemental Downlink

Spectrum for 5G (All bands in LTE + More)

- Bands to be studied already assigned to the mobile service on a primary basis
 - 24.25-27.5 GHz
 - 37-40.5 GHz
 - 42.5-43.5 GHz
 - 45.5-47 GHz
 - 47.2-50.2 GHz
 - 50.4-52.6 GHz
 - 66-76 GHz
 - 81-86 GHz
- Bands to be studied not assigned to the mobile service on a primary basis
 - 31.8-33.4 GHz (aeronautical and shipborne radar)
 - 40.5-42.5 GHz (satellite)
 - 47-47.2 GHz (amateur satellite radio)

Bands for 5G NR in FR1 (below 6 GHz)

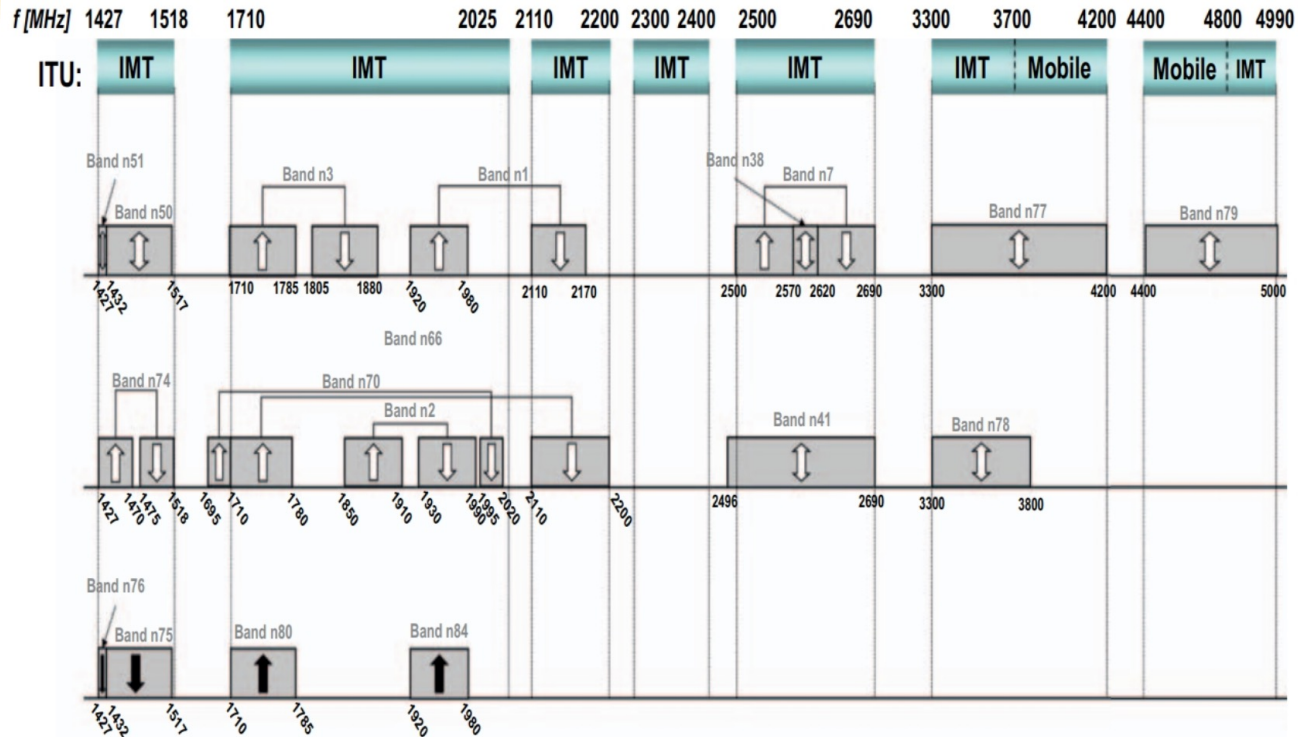

Bands for 5G NR in FR2 (24.2-52.6 GHz.)

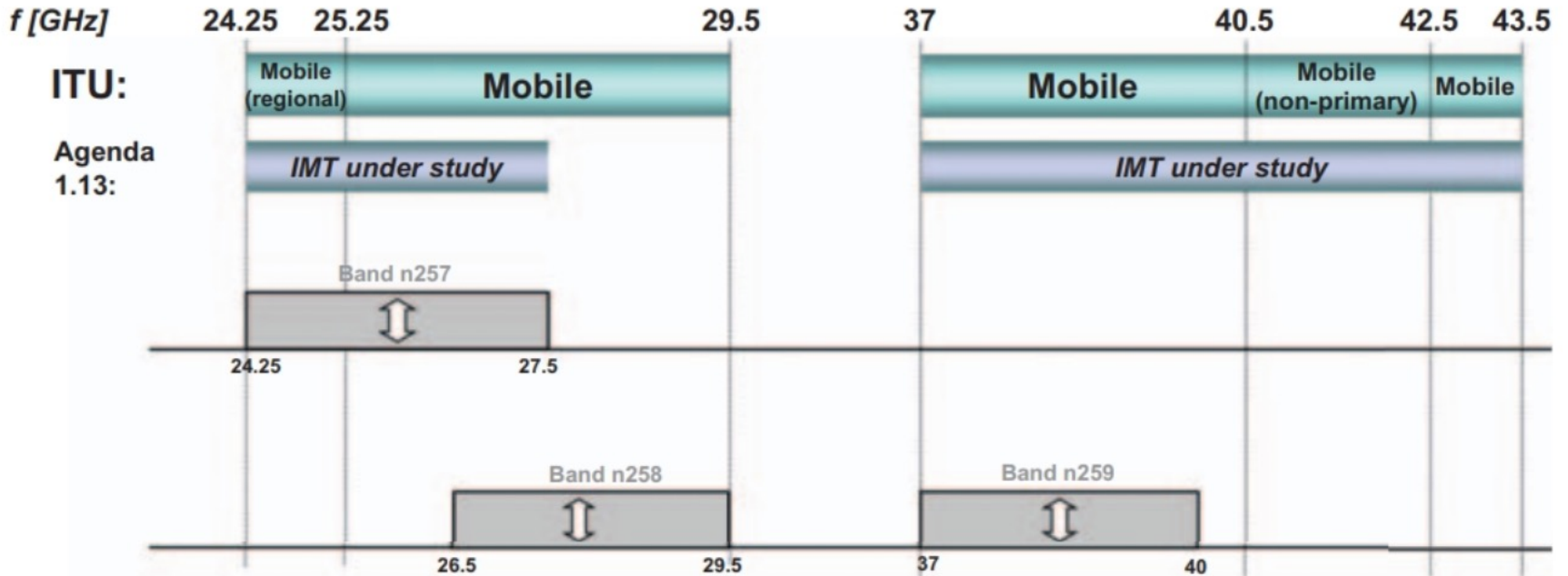

Legend:

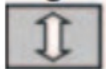

Unpaired

RF Exposure Limits

- Mandated
 - Recommended by International Commission on Non-Ionizing Radiation (ICNIRP)
 - Specified by the Federal Communications Commission (FCC) in the US
- Set with wide safety margins to protect against excessive heating of tissue due to energy absorption
- Energy absorption in tissue becomes increasingly superficial with increasing frequency, and thereby more difficult to measure
- To be compliant with ICNIRP at the higher frequencies, the transmit power might have to be **up to 10 dB below** the power levels used for current cellular technologies

LTE Releases

Rel-8

Dec. 2008

- First release for
- LTE
 - EPC/SAE

Rel-9

Dec. 2009

- LTE Home NodeB
- Location Services
- MBMS support
- Multi-standard BS

Rel-10

Mar. 2011

“LTE-Advanced”

- Carrier aggregation
- Enhanced downlink MIMO
- Uplink MIMO
- Enhanced ICIC
- Relays

Rel-11

Sep. 2012

- Carrier aggregation enhancements
- Enhanced heterogeneous deployments
- CoMP

Rel-12

Sep. 2014

- Small cell enhancements
- Lean carrier
- Multi-antenna enhancements
- D2D

Rel-13

Dec. 2015

“LTE-Advanced Pro”

- MTC enhancements
- License Assisted Access
- Narrowband IoT
- FD-MIMO
- Dual connectivity

LTE Core Network

- RAN: Radio Access Network
- S-GW: Serving Gateway
- P-GW: Packet Data Network Gateway
- MME: Mobility Management Entity
- HSS: Home Subscriber Service
- EPC: Evolved Packet Core
- EPC and LTE RAN is together termed EPS (Evolved Packet Service)

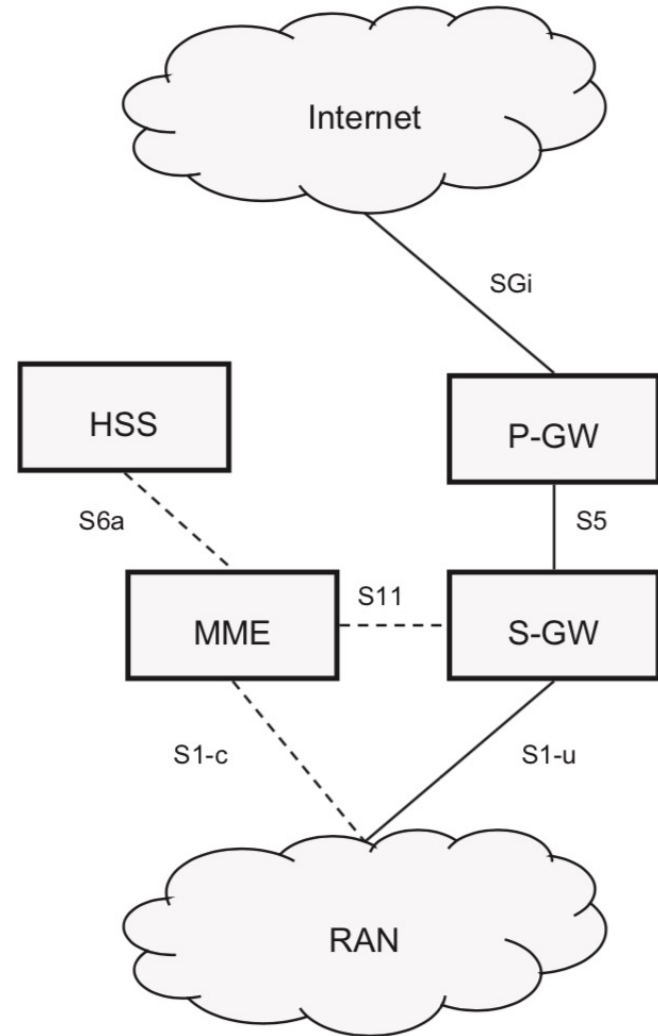

Path to Internet

➤ User Equipment (UE) to the Internet

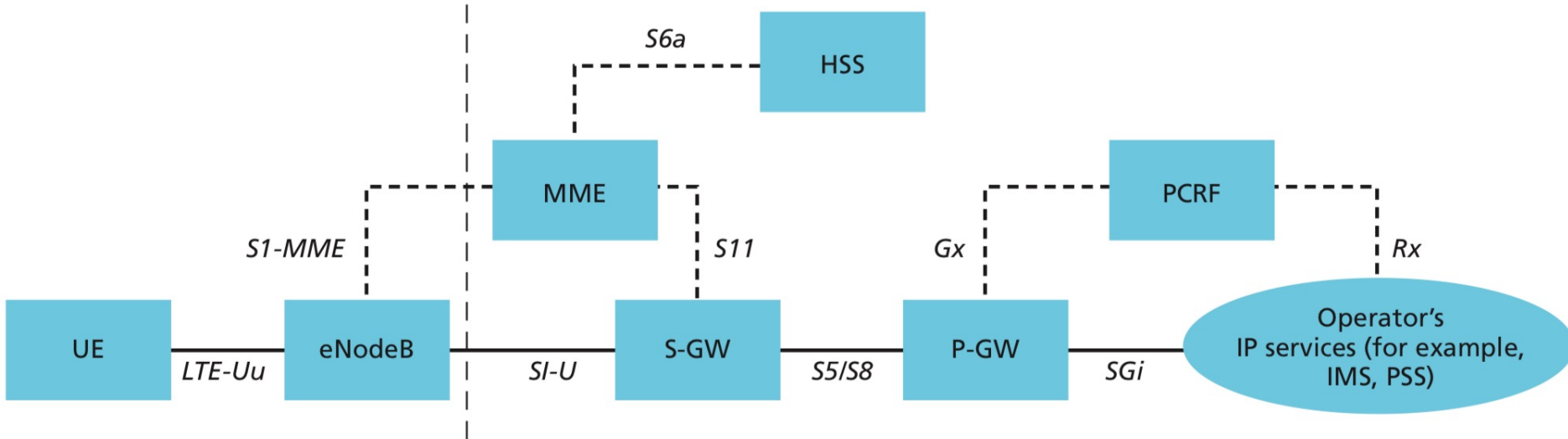

Evolved Packet System (EPS)

- RAN: Radio related functionalities
 - scheduling, radio-resource handling, retransmission protocols, coding, and various multi-antenna schemes
- EPC: functionalities needed for providing a complete mobile-broadband network
 - authentication, charging functionality, and setup of end-to-end connections
- Why two separate entities?

Modules of EPC

➤ MME

- Control-plane node of the EPC.
- Handles connection/release of bearers to a device, handling of IDLE to ACTIVE transitions, and handling of security keys.

➤ S-GW

- User-plane node connecting the EPC to the LTE RAN.
- The S-GW acts as a mobility anchor when devices move between eNodeBs.
- Collection of information and statistics necessary for charging is also handled by the S-GW.

Modules of EPC

➤ P-GW

- connects the EPC to the internet
- Allocation of the IP address for a specific device
- quality- of-service (QoS) enforcement

➤ HSS

- a database containing subscriber information

➤ Other modules:

- Multimedia Broadcast Multicast Services (MBMS)
- The Policy Control and Charging Rules Function (PCRF)

Radio Access Network Interfaces

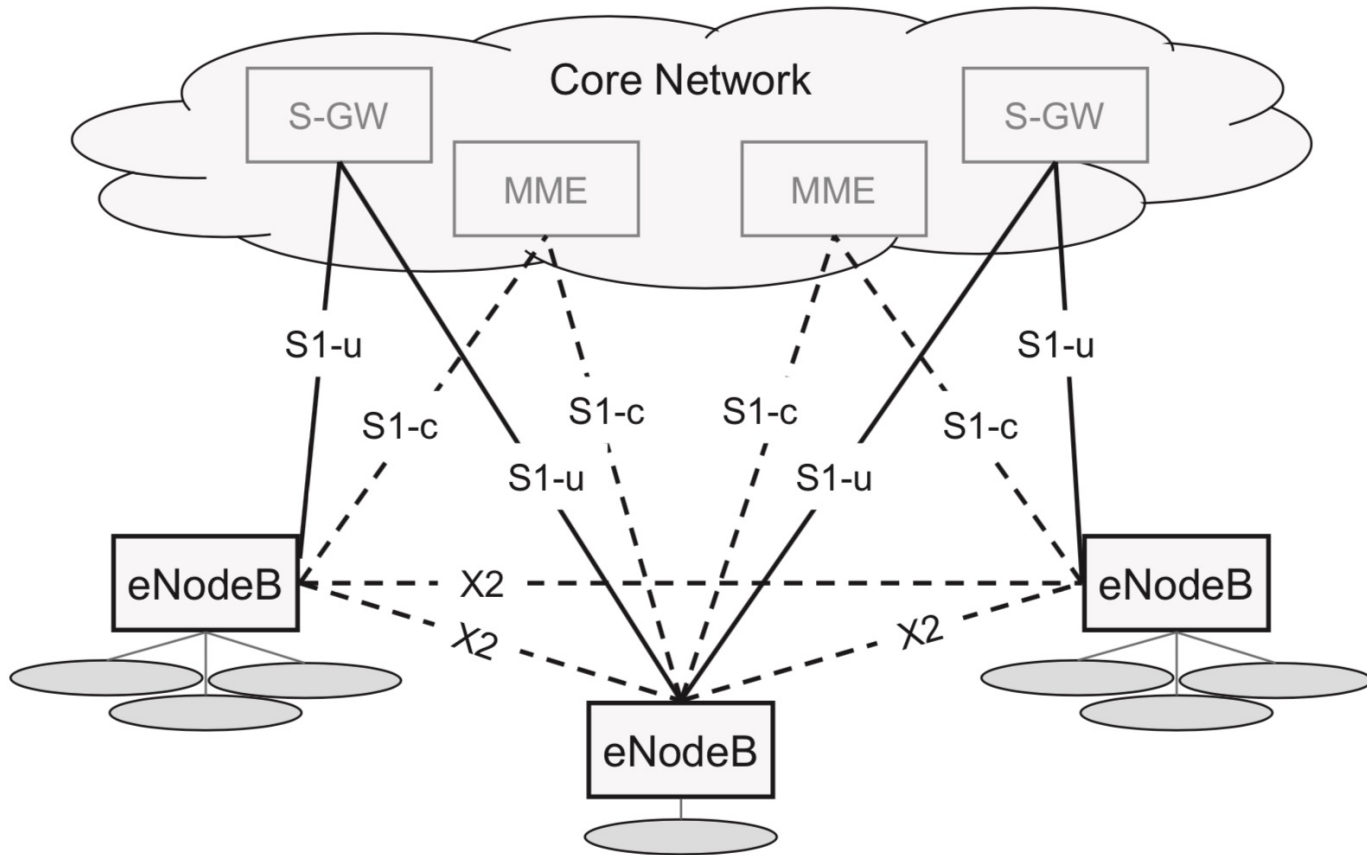

eNodeB (evolved NodeB)

➤ eNodeB:

- logical representation
- physical implementation can be a three-sector BS
- can be a BBU pool, where RRH are connected remotely

➤ Interfaces:

- S1: connection between eNB and EPC (S1-U and S1-C)
- X2: connecting eNBs for active mode mobility, multi-cell radio resource management (RRM)

5G Core Network Architecture

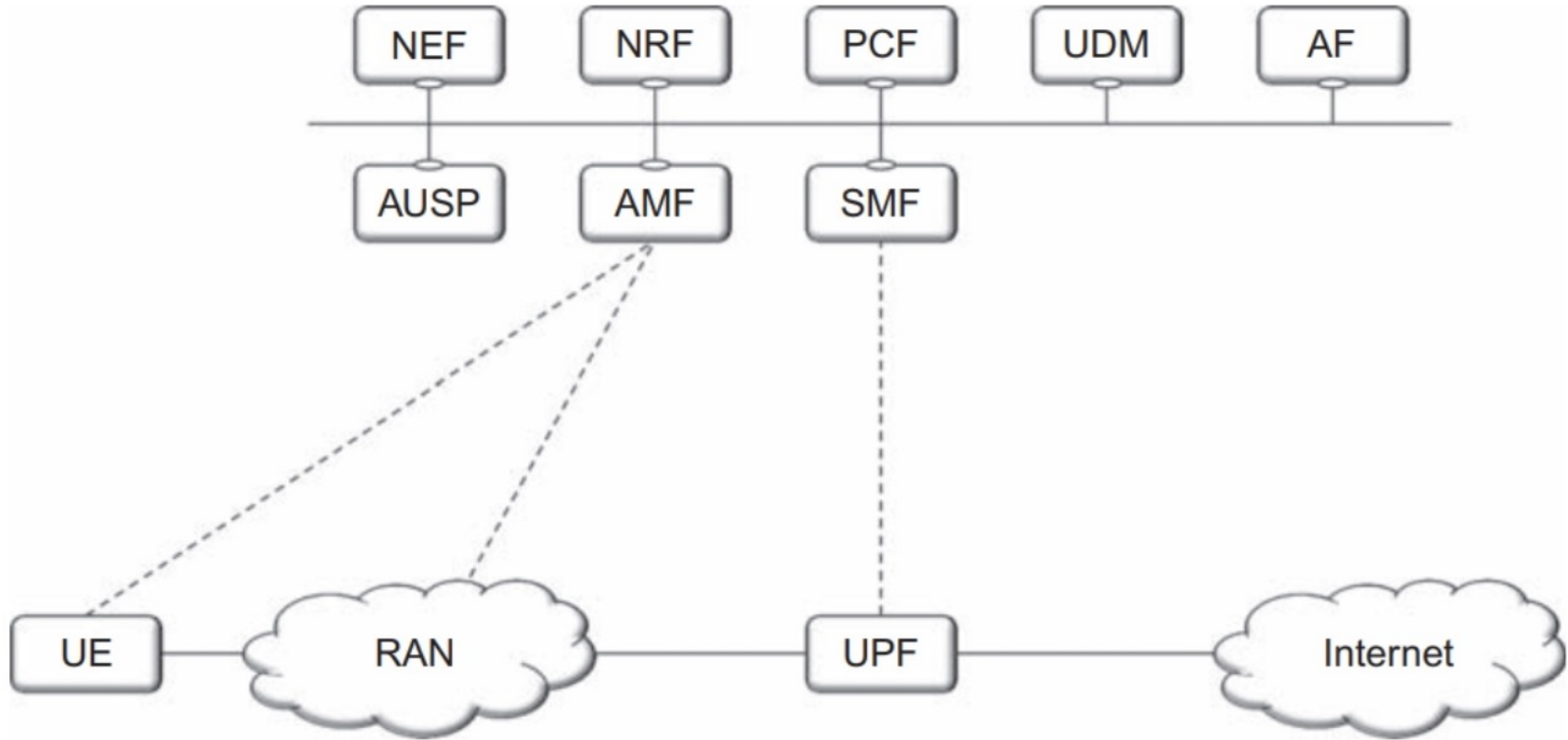

Modules of 5G

➤ User Plane Function (UPF):

- Gateway between the RAN and external networks such as the Internet.
- Handles packet routing and forwarding, packet inspection, quality-of-service handling and packet filtering, and traffic measurements.
- Serves as an anchor point for (inter-RAT) mobility when necessary.

➤ Session Management Function (SMF):

- Handles IP address allocation for the UE, control of policy enforcement, and general session-management functions.

Modules of 5G

- The Access and Mobility Management Function (AMF):
 - handles control signaling between the core network and the device, security for user data, idle-state mobility, and authentication.
- Other functions:
 - the Policy Control Function (PCF) responsible for policy rules,
 - the Unified Data Management (UDM) responsible for authentication credentials and access authorization
 - the Network Exposure Function (NEF)
 - the NR Repository Function (NRF)
 - the Authentication Server Function (AUSF) handling authentication functionality
 - the Application Function (AF).

Combination of Core Networks & RATs

- eNodeB – evolved Node B
- gNodeB – next generation Node B

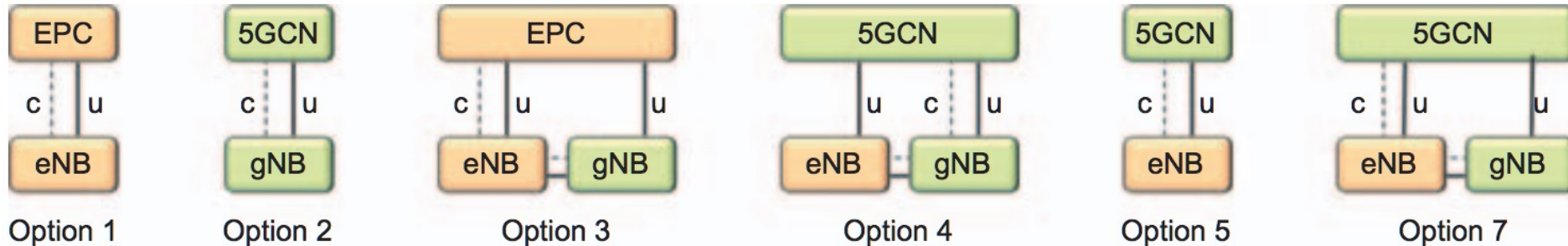

RAN Protocol Architecture

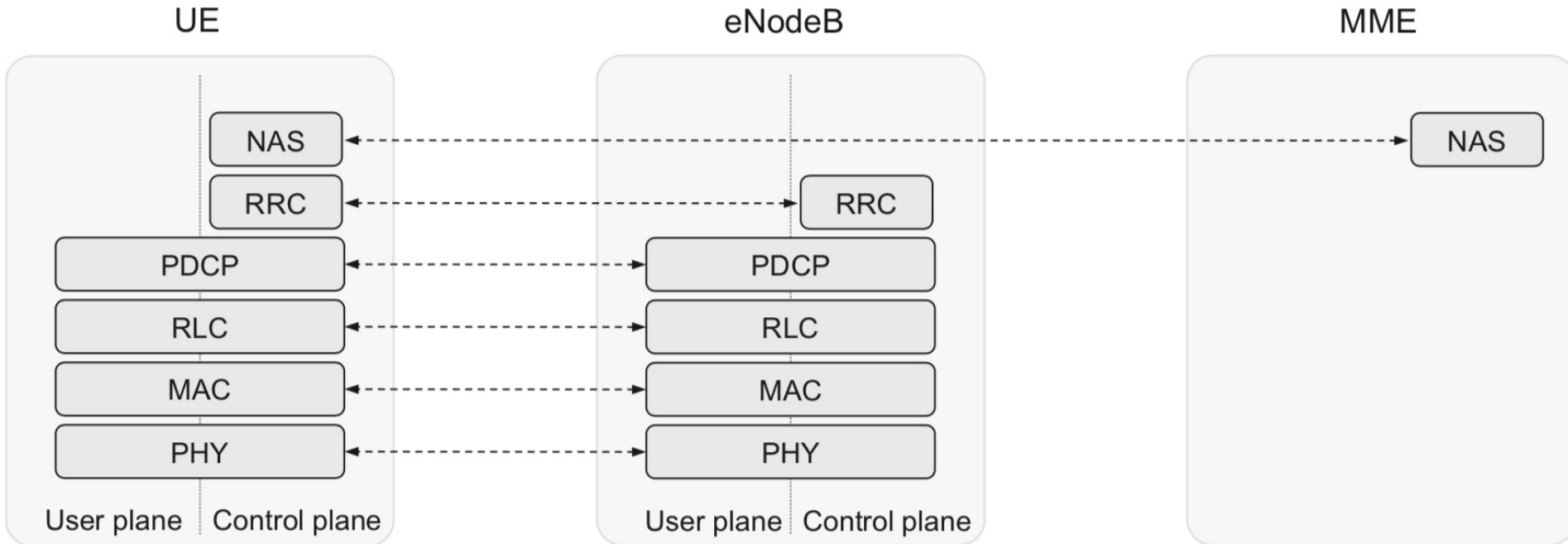

Protocol

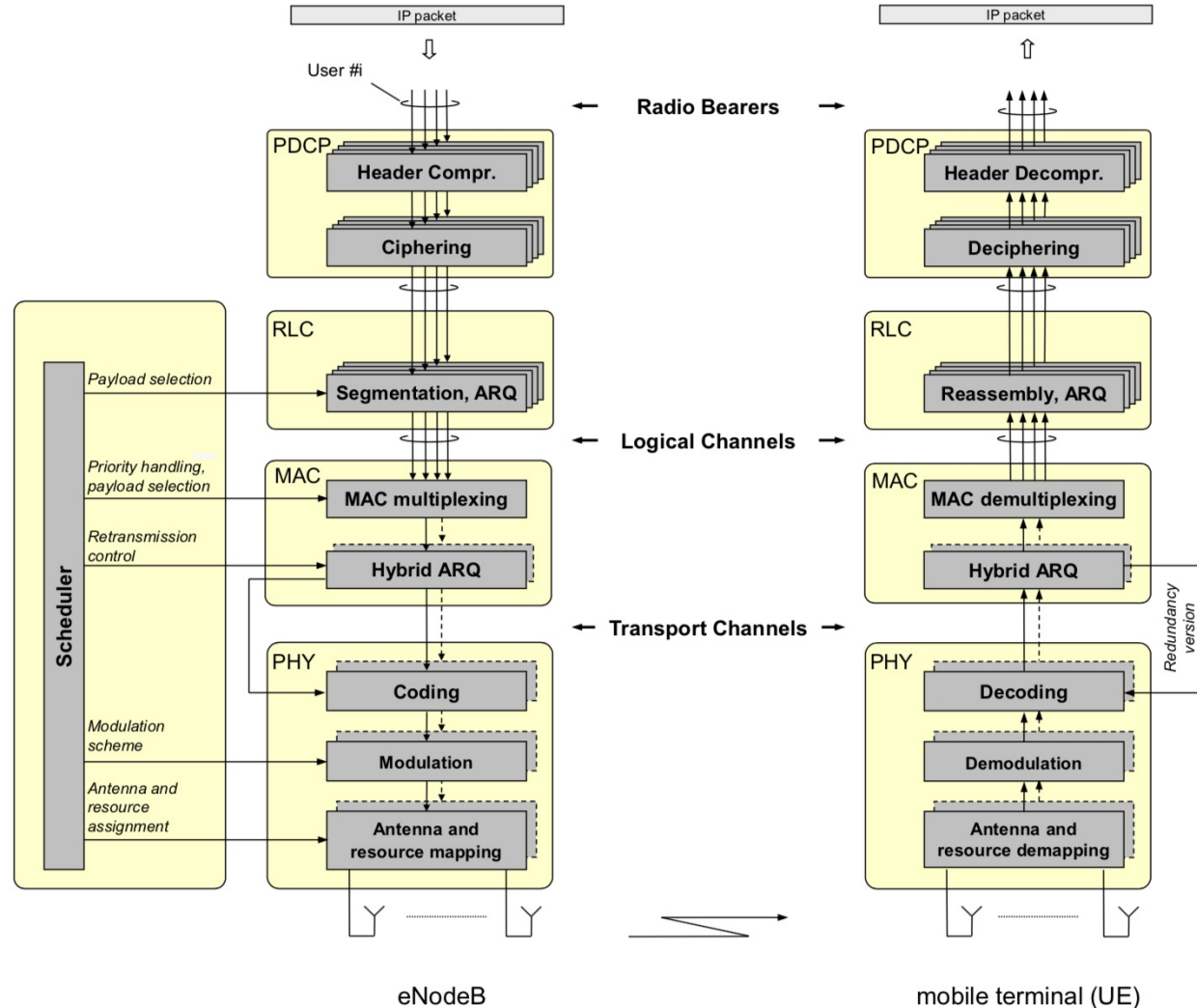

Protocol Entities of the RAN

- Packet data convergence protocol (PDCP)
 - performs IP header compression, ciphering, and integrity protection.
 - handles in-sequence delivery and duplicate removal in case of handover.
- Radio-link control (RLC)
 - responsible for segmentation/concatenation, retransmission handling, duplicate detection, and in-sequence delivery to higher layers.
 - provides services to the PDCP.

Protocol Entities of the RAN

- Medium-access control (MAC)
 - handles multiplexing of logical channels, hybrid-ARQ retransmissions, and uplink and downlink scheduling.
 - The scheduling functionality is located in the eNodeB for both uplink and downlink.
 - The hybrid-ARQ protocol part is present in both the transmitting and receiving ends of the MAC protocol.
 - The MAC provides services to the RLC in the form of logical channels.

Protocol Entities of the RAN

- Physical layer (PHY)
 - coding/decoding, modulation/demodulation, multi-antenna mapping, and other typical physical-layer functions.
 - The physical layer offers services to the MAC layer in the form of transport channels.

LTE Data Flow

